

The Holzworth HS9000 Series multi-channel platform is designed to achieve optimal channel-to-channel stability across all integrated channel synthesizers via a conductively cooled, fan-less enclosure. Specific attention is paid to phase coherency between the independently controllable channels.



The HS9000 Series is a unique platform allowing the user to specify custom configurations for a COTS product. Units are loaded with anywhere from 1 to 8 channels¹, with the additional flexibility to specify each channel's frequency limits and performance options. The result is a high performance, multi-channel synthesizer that is tailored to an application with an optimal price point.

FULLY INDEPENDENT CHANNELS

Each RF output is driven by a separate, internally loaded synthesizer module. Up to 8¹ independently tunable synthesizers can be specified per 1U chassis allowing for the highest integrated channel density available in its class. With an average power dissipation of 7 Watts per channel, the HS9000 series is highly efficient.

PHASE COHERENT CHANNELS

Holzworth Multi-channel RF Synthesizers offer the benefits of a proprietary NON-PLL based synthesis architecture. Coupling the NON-PLL architecture with a centralized reference distribution subsystem enables a truly phase coherent relationship across all integrated channels.

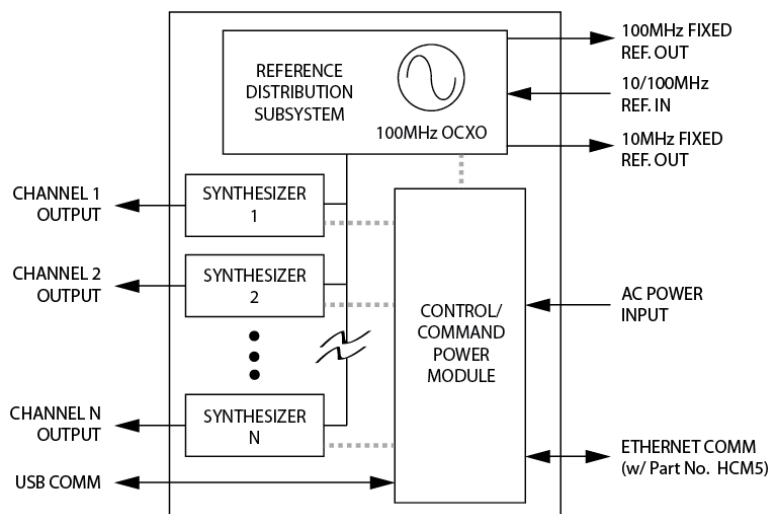

THE ULTIMATE IN CHANNEL-TO-CHANNEL STABILITY

Different from traditional PLL based synthesizers, Holzworth's proprietary architecture creates precisely synthesized signals that exhibit both instantaneous and long term stability. Temperature variations between the channels remain the only contribution to drift. The thermally optimized, fan-less chassis was specifically developed for maintaining the lowest possible thermal gradients from channel-to-channel.

Holzworth multi-channel designs are integrated into precision applications that range from particle accelerator timing clocks to satellite position tracking. Due to the necessity for the ultimate in signal stability, Holzworth synthesizers also come standard with thermal monitor outputs to track the relative channel temperature of each loaded channel.

¹Number of channels per 1U chassis can be limited based on options selected.

ELECTRICAL SPECIFICATIONS - FREQUENCY

The specified parameters for the HS9000 Series RF Synthesizers are fully verified at final performance test and 100% guaranteed for the warranted life of the product. Performance specifications listed on this page are specific to Frequency.

FREQUENCY PERFORMANCE (channels up to 6.4 GHz)¹

PARAMETER	MIN ²	TYPICAL ³	MAX ²	COMMENTS
Frequency Option Ranges⁴ OPT-A1 thru OPT-A8 OPT-B1 thru OPT-B8 OPT-C1 thru OPT-C8 OPT-D1 thru OPT-D8 OPT-E1 thru OPT-E8	250 kHz 250 kHz 250 kHz 250 kHz 250 kHz		1.024 GHz 2.048 GHz 3.072 GHz 4.096 GHz 6.400 GHz	Settable from 100 kHz. Settable from 100 kHz. Settable from 100 kHz. Settable from 100 kHz. Settable from 100kHz to 6.720 GHz
Frequency Resolution		0.001 Hz		
Phase Offset Resolution 250 kHz – 512 MHz 512 MHz – 1.024 GHz 1.024 GHz – 2.048 GHz 2.048 GHz – 4.096 GHz 4.096 GHz – 6.40 GHz		0.1 deg 0.2 deg 0.4 deg 0.8 deg 1.6 deg		Offset Accuracy: ±0.05 deg ±0.10 deg ±0.20 deg ±0.40 deg ±0.80 deg
Switching Speed (Frequency) SPI Mode (ASCII) SPI Mode (Binary) List/Step Sweep Mode (WB) List/Step Sweep Mode (NB)		300 µs maximum by design. < 3.072 GHz, 100 µs maximum by design. 75 µs typical. ≥ 3.072 GHz, 100 µs by design. 100 µs by design. Wideband Steps (full bandwidth) 6 µs by design. Narrowband Steps (<5% bandwidth)		
Internal Time Base Reference (Oscillator Aging Rate)		± 1 ppm/yr		1 st year. ±0.5 ppm/yr each subsequent year
Temperature Effects		± 1 ppm		0 to 55 °C
Line Voltage Effects (12V)		± 0.1 ppm		• ±5%
10 MHz Reference Output Amplitude Impedance		+ 5 dBm 50 Ω		Fixed, Nominal Nominal
100 MHz Reference Output Amplitude Impedance		+ 5 dBm 50 Ω		Fixed, Nominal Nominal
External Reference Input Input Frequency 10MHz Lock Range 10MHz External Amplitude 100MHz External Amplitude Impedance Waveform	0 dBm +2 dBm	10 / 100 ± 4 ppm 50 Ω	± 1 ppm +10 dBm +6 dBm	10MHz or 100MHz Auto-detect, or Internal Ref. 20Hz Locking BW, Internal OCXO remains on 20Hz Locking BW, Internal OCXO remains on Internal OCXO shuts off 50 Ω (nom) Sine
Digital Sweep Modes Operating Modes Sweep Range Dwell Time Number of Points (STEP) Number of Points (LIST) Triggering	250 kHz 100 µs 2 2		6.720 GHz 100 s 65535 3201	Step sweep (linear, internal) List Sweep (arbitrary list of freq steps) Simultaneous Amplitude sweep (list) 1 µs increments Free Run, External Trigger

¹ Specifications are subject to change per the discretion of Holzworth Instrumentation, Inc.

² All MIN/ MAX (Minimum/ Maximum) performance parameters are guaranteed and 100% verified during final performance test.

³ Typical performance is "by design" and consistent with field performance data.

⁴ Option OPT-PWR18 limits calibrated minimum frequency to 32MHz

ELECTRICAL SPECIFICATIONS - FREQUENCY (continued)

FREQUENCY PERFORMANCE (12.5 and 20 GHz channels)¹

PARAMETER	MIN ²	TYPICAL ³	MAX ²	COMMENTS
Frequency Range OPT-X1 thru OPT-X4 OPT-F1 thru OPT-F4	10 MHz 10 MHz		12 GHz 18 GHz	VHF through X Band (Settable to 12.5GHz) VHF through K _u Band (Settable to 22.5GHz)
Frequency Step Size		0.001 Hz		
Phase Offset	0 deg		+360 deg	
Phase Offset Resolution 250 kHz – 512 MHz 512 MHz – 1.024 GHz 1.024 GHz – 2.048 GHz 2.048 GHz – 4.096 GHz 4.096 GHz – 5.0 GHz 5.0 GHz – 10 GHz 10 GHz – 20GHz		0.1 deg 0.2 deg 0.4 deg 0.8 deg 1.6 deg 3.2 deg 6.4 deg		Offset Accuracy: ±0.05 deg ±0.10 deg ±0.20 deg ±0.40 deg ±0.80 deg ±1.60 deg ±3.20 deg
Switching Speed (Frequency) SPI Mode (ASCII) SPI Mode (Binary)			300us 100us	
Internal Time Base Reference (Oscillator Aging Rate)		± 1 ppm/yr		1 st year. ±0.5 ppm/yr each subsequent year
Temperature Effects		± 1 ppm		0 to 55 °C
Line Voltage Effects (12V)		± 0.1 ppm		±5%
Reference Output Frequency Amplitude Impedance	+2 dBm	100 MHz 50 Ω	+6 dBm	Nominal Nominal
External Reference Input Input Frequency 10MHz Lock Range 10MHz External Amplitude 100MHz External Amplitude Impedance Waveform	0 dBm +2 dBm	10 / 100 ± 4 ppm 50 Ω	± 1 ppm +10 dBm +6 dBm	Software Select 10MHz, 100MHz or No Ext. Ref. 20Hz Locking BW, Internal OCXO remains on 20Hz Locking BW, Internal OCXO remains on Internal OCXO shuts off 50 Ω (nom) Sine

¹ Specifications are subject to change per the discretion of Holzworth Instrumentation, Inc.

² All MIN/ MAX (Minimum/ Maximum) performance parameters are guaranteed and 100% verified during final performance test.

³ Typical performance is "by design" and consistent with field performance data.

⁴ Option OPT-PWR18 limits calibrated minimum frequency to 32MHz

ELECTRICAL SPECIFICATIONS - AMPLITUDE

The specified parameters for the HS9000 Series RF Synthesizers are fully verified at final performance test and 100% guaranteed for the warranted life of the product. Performance specifications listed on this page are specific to Amplitude.

AMPLITUDE PERFORMANCE (channels up to 6.4 GHz)¹

PARAMETER	MIN ²	TYPICAL ³	MAX ²	COMMENTS
Output Power	-70 dBm		+10 dBm	Settable from -100 to +15 dBm
Output Power with +18dBm Option	-60 dBm		+20dBm	(See information on p. 19)
Resolution		0.01 dB		
Step Attenuator	0 dB		100 dB	5 dB steps
Connector		50 Ω		SMA
SWR				
f < 32MHz 32MHz < f < 1.024GHz 1.024GHz < f < 6.720GHz		1.4 (-15.6 dB) 1.15 (-23.0 dB) 1.3 (-17.7 dB)	1.7 (-11.7 dB) 1.4 (-15.6 dB) 1.5 (-14 dB)	
Maximum Reverse Power Max DC Voltage > 100 kHz	25 VDC maximum by design. *** Some applications may require reverse power protection. 10 mW (10dBm) max by design.			
Switching Speed (Amplitude) SPI Mode List / Step Sweep Mode	300 μs maximum by design. Settling to within 0.1 dB. 100 μs maximum by design.			
Absolute Level Accuracy f < 10MHz 10MHz < f < 32MHz 32MHz < f < 4.096GHz 32MHz < f < 4.096GHz 4.096GHz < f < 6.4GHz 4.096GHz < f < 6.4GHz	0 to -70dBm 0 to -70dBm +10 to -30dBm -30 to -70dBm +10 to -30dBm -30 to -60dBm	+0.25/ -2.0 dB +0.1/ -1.25 dB ± 0.10 dB ± 0.25 dB ± 0.15 dB ± 0.25 dB	NS +0.6/ -2.0 dB ± 0.5 dB ± 1.0 dB ± 0.6 dB ± 1.1 dB	} 25C to 35C (case temperature)
SSB Phase Noise 100 MHz, 10kHz offset 500 MHz, 10kHz offset 1.0 GHz, 10kHz offset 2.0 GHz, 10kHz offset 3.0 GHz, 10kHz offset 4.0 GHz, 10kHz offset 6.0 GHz, 10kHz offset		≤ -153 dBc/Hz ≤ -139 dBc/Hz ≤ -133 dBc/Hz ≤ -127 dBc/Hz ≤ -123 dBc/Hz ≤ -121 dBc/Hz ≤ -117 dBc/Hz	≤ -145 dBc/Hz ≤ -134 dBc/Hz ≤ -128 dBc/Hz ≤ -122 dBc/Hz ≤ -117 dBc/Hz ≤ -115 dBc/Hz ≤ -111 dBc/Hz	
Harmonics (CW mode) Pout = 0dBm Pout = +10dBm		-40 dBc -30 dBc	-30 dBc NS	
Non-Harmonics (CW mode) 250 kHz to 3.072 GHz 3.072 GHz to 6.400 GHz		-70 dBc -60 dBc	-60 dBc -50 dBc	@ 0 dBm @ 0 dBm
Sub-Harmonics (CW mode) 250 kHz to 3.072 GHz 3.072 GHz to 6.400 GHz		-70 dBc -60 dBc	-60 dBc -50dBc	@ 0 dBm @ 0 dBm
Jitter 155 MHz 622 MHz 2.488 GHz		60 fs 61 fs 55 fs	NS NS NS	100Hz < BW < 1.5MHz 1kHz < BW < 5MHz 5kHz < BW < 20MHz

¹ Specifications are subject to change per the discretion of Holzworth Instrumentation, Inc.

² All MIN/ MAX (Minimum/ Maximum) performance parameters are guaranteed and 100% verified during final performance test.

³ Typical performance is "by design" and consistent with field performance data.

ELECTRICAL SPECIFICATIONS - AMPLITUDE (continued)

AMPLITUDE PERFORMANCE (12.5 and 20 GHz channels)¹

PARAMETER	MIN ²	TYPICAL ³	MAX ²	COMMENTS
Output Power (Calibrated) 10 MHz to 12 GHz 12 GHz to 18 GHz	-10 dBm -10 dBm		+18 dBm +16 dBm	Settable -20 to +23 dBm
Resolution		0.01 dB		
Connector		50 Ω		SMA
SWR (S₁₁) 10 MHz < f ≤ 6 GHz 6 GHz < f ≤ 18 GHz		1.33 (-17.0 dB) 1.43 (-15.0 dB)		
Maximum Reverse Power Max DC Voltage > 100 kHz	25 V _{DC} maximum by design. *** Some applications may require reverse power protection. 16 dBm max by design.			
Switching Speed (Amplitude)			100us	Settling to within 0.1dB
Absolute Level Accuracy 10 MHz - 6 GHz 6 GHz - 12 GHz -10 dBm to 5 dBm 5 dBm to 18 dBm 12 GHz - 18 GHz -10 dBm to 5 dBm 5 dBm to 16 dBm		± 0.5 dB ± 0.5 dB ± 1 dB ± 0.6 dB ± 1.1 dB		25C to 35C (case temperature)
SSB Phase Noise 2.0 GHz, 10 kHz offset 4.0 GHz, 10 kHz offset 8.0 GHz, 10 kHz offset 12.0 GHz, 10 kHz offset 18.0 GHz, 10 kHz offset		≤ -128 dBc/Hz ≤ -122 dBc/Hz ≤ -114 dBc/Hz ≤ -110 dBc/Hz ≤ -106 dBc/Hz		
Harmonics (CW mode)		-30 dBc		
Non-Harmonics (CW mode) 10 MHz to 8 GHz 8 GHz to 18 GHz		-60 dBc -50 dBc		
Sub-Harmonics (CW mode) 10 MHz to 8 GHz 8 GHz to 18 GHz		-60 dBc -50 dBc		
Jitter (RMS) at 18 GHz		55 fs		5 kHz < BW < 20 MHz

¹ Specifications are subject to change per the discretion of Holzworth Instrumentation, Inc.

² All MIN/ MAX (Minimum/ Maximum) performance parameters are guaranteed and 100% verified during final performance test.

³ Typical performance is "by design" and consistent with field performance data.

ELECTRICAL SPECIFICATIONS - AMPLITUDE (continued)

TYPICAL AMPLITUDE PERFORMANCE (12 and 20 GHz channels)

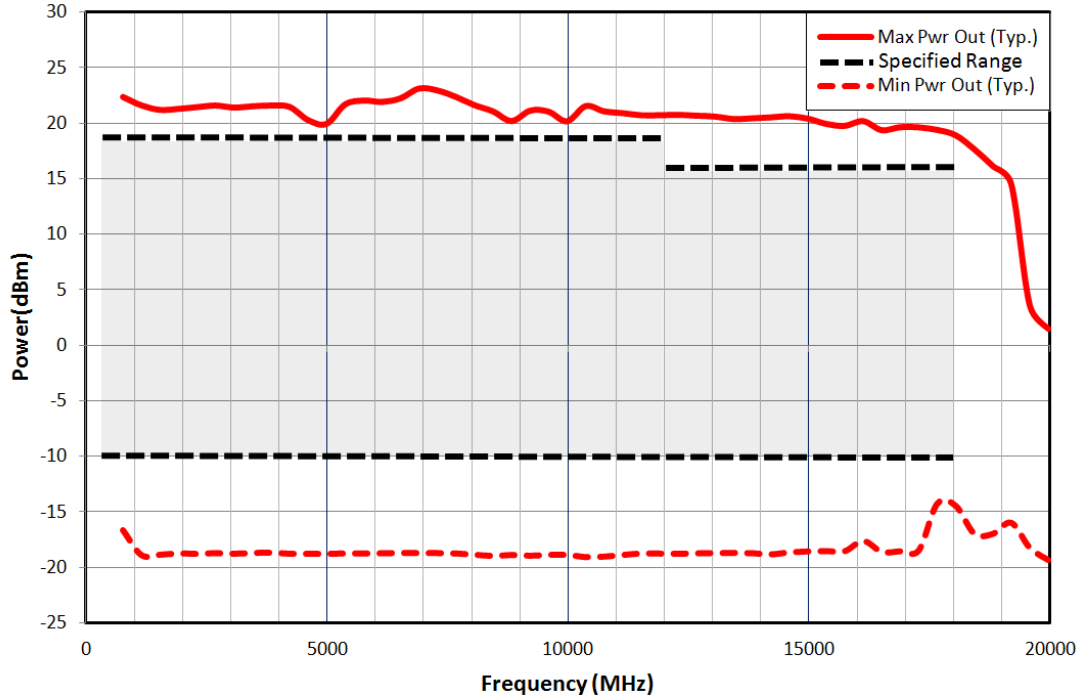

Figure 1: Maximum and Minimum Amplitude Threshold

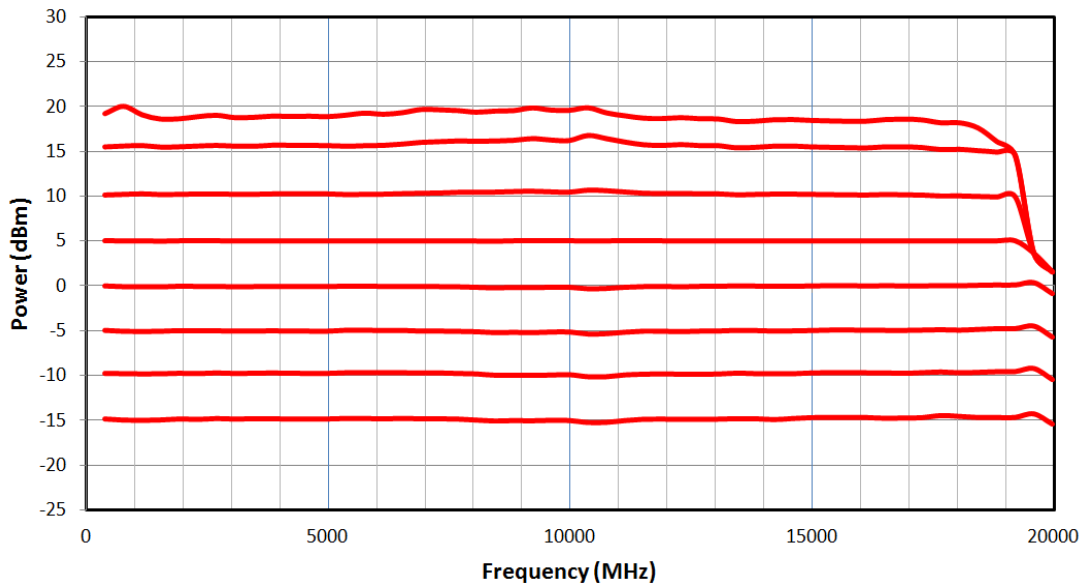

Figure 2: Calibrated Output Power Accuracy vs. Frequency

ELECTRICAL SPECIFICATIONS - MODULATION

The external stimulus modulation parameters are only available on units equipped with option OPT-EXTMOD. Units with OPT-EXTMOD have channel dedicated modulation input ports installed.

EXTERNAL MODULATION (channels up to 6.4 GHz)¹

PARAMETER	PERFORMANCE	COMMENTS
FREQUENCY MODULATION (Analog)		
Max Deviation	100 kHz	
Resolution	0.01% or 1mHz, whichever is greater	
Deviation Accuracy	< ± 2%	
Modulation Freq. Response	DC to 20 kHz (-3dB)	DC Coupled
Sensitivity when using Ext. Input	± 1V peak into 50Ω	+ 1V: Maximum Positive Deviation 0V: Zero Deviation from Carrier - 1V: Maximum Negative Deviation
PHASE MODULATION (Analog)		
Modulation Deviation	±1.6 deg to ±180 deg	
Frequency Response	DC to 20 kHz (-3dB)	DC Coupled
Resolution	Frequency Dependent	See Phase Offset Specification
Sensitivity when using Ext. Input	± 1V peak into 50Ω	+ 1V: Maximum Positive Deviation 0V: Zero Deviation from Carrier - 1V: Maximum Negative Deviation
AMPLITUDE MODULATION (Analog)		
AM Depth Type	Linear	
Depth		0.45 dB to 12 dB
Maximum	5% to 75%	
Resolution	<3% of Maximum Depth	
Depth Accuracy	5% of Maximum Depth	
Modulation Rate	DC to 10 kHz (-3dB)	DC Coupled
Sensitivity when using Ext. Input	± 1V peak for indicated Depth (into 50Ω)	+ 1V: Maximum Amplitude 0V: 50% of Maximum Depth - 1V: Maximum Depth
PULSE MODULATION (Analog)		
Risetime (T _r)	<100 ns	
Falltime (T _f)	<100 ns	
On/Off Ratio	> 70dB	
Minimum Pulse Width	200 ns	
ALC Loop Deviation (ALC disabled)	1dB difference from ALC enabled	

¹ Specifications are subject to change per the discretion of Holzworth Instrumentation, Inc

PARAMETER	PERFORMANCE	COMMENTS
External Trigger Threshold	+1.2V	±5% into 50Ω

ELECTRICAL SPECIFICATIONS - MODULATION (continued)

HSM Series synthesizers up to 6.4GHz maximum output frequency that have firmware version 3.3.1 or higher, are capable of operating in internal pulse modulation mode, which does not require an external stimulus signal.

SELF PULSE MODULATION (channels up to 6.4 GHz)¹

PARAMETER	PERFORMANCE	COMMENTS
Risetime (T_r) fc < 512MHz fc > 512 MHz	11ns (typical)	
Falltime (T_f)	<100 ns	
On/Off Ratio	> 70dB	
Minimum Pulse Width	200 ns	
ALC Loop Deviation (ALC disabled)	1dB difference from ALC enabled	

¹ Specifications are subject to change per the discretion of Holzworth Instrumentation, Inc

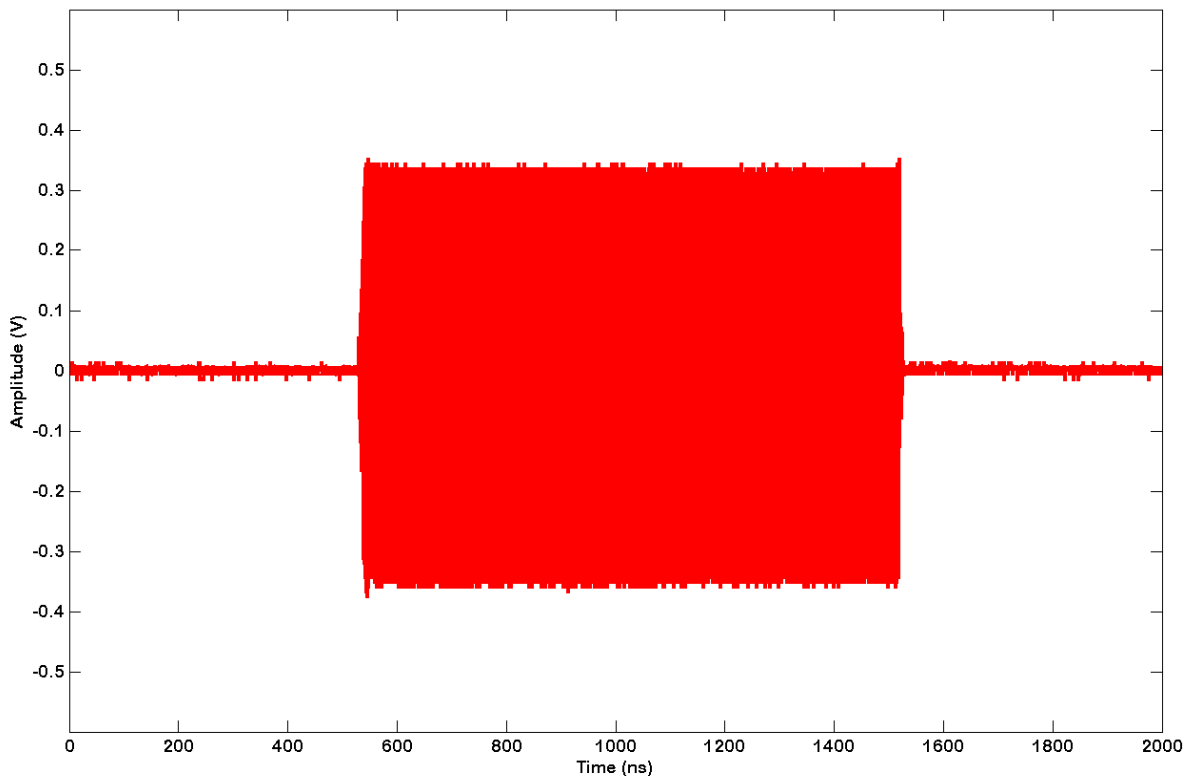
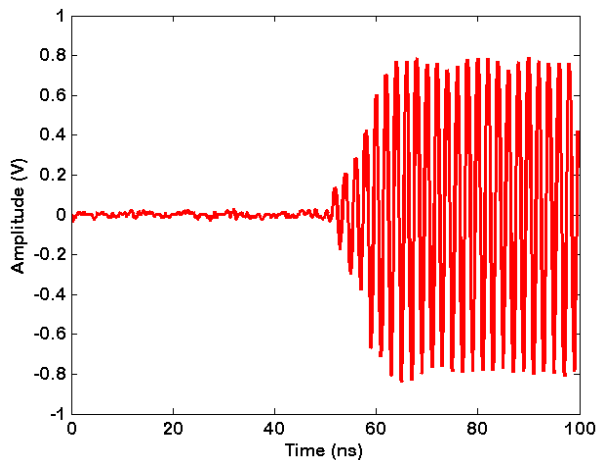
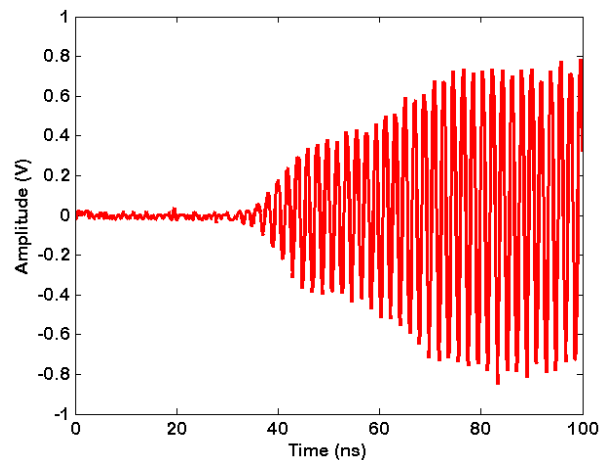
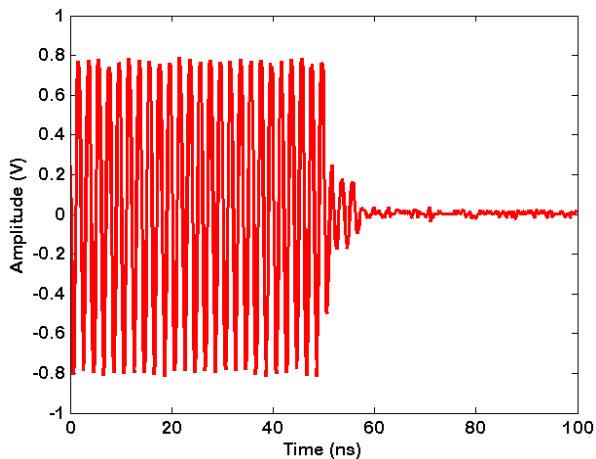
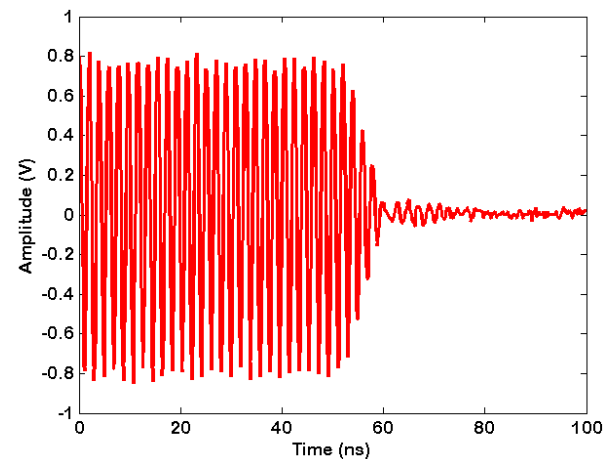

Figure 1: Self Pulse Mod $f_c = 500\text{MHz}$, 2us Pulse²

² Internal pulse modulation for frequencies greater than 512MHz will exhibit increased settling time. Contact Holzworth customer support for additional data.

ELECTRICAL SPECIFICATIONS - MODULATION (continued)**SELF PULSE MODULATION (channels up to 6.4 GHz, continued)**

Pulse modulation will exhibit longer rise/fall times for frequencies greater than 512 MHz. Figures 2 and 3 below demonstrate this difference between set frequencies.

**Figure 2a: Pulse Mod Rise Time, $f_c = 500\text{MHz}$** **Figure 2b: Pulse Mod Rise Time, $f_c = 530\text{MHz}$** **Figure 3a: Pulse Mod Fall Time, $f_c = 500\text{MHz}$** **Figure 3b: Pulse Mod Fall Time, $f_c = 530\text{MHz}$**

ELECTRICAL SPECIFICATIONS - MODULATION (continued)

Modulation capabilities on channels equipped with OPT-X1 or OPT-F1 are different than those on the lower frequency channels. Currently modulation is limited to externally driven pulse modulation. This pulse modulation exhibits better performance than the same capability on the lower frequency channels, however.

EXTERNAL MODULATION (12.5 and 20 GHz channels)

PARAMETER	PERFORMANCE	COMMENTS
Risetime (T_r)	<20 ns	
Falltime (T_f)	<20 ns	
On/Off Ratio 10MHz to 10GHz 10GHz to 20GHz	> 80dB > 50dB	
Minimum Pulse Width	50 ns	
ALC Loop Deviation (ALC disabled)	1dB difference from ALC enabled	

¹ Specifications are subject to change per the discretion of Holzworth Instrumentation, Inc

PARAMETER	PERFORMANCE	COMMENTS
External Trigger Threshold	+1V	±5% into 50Ω

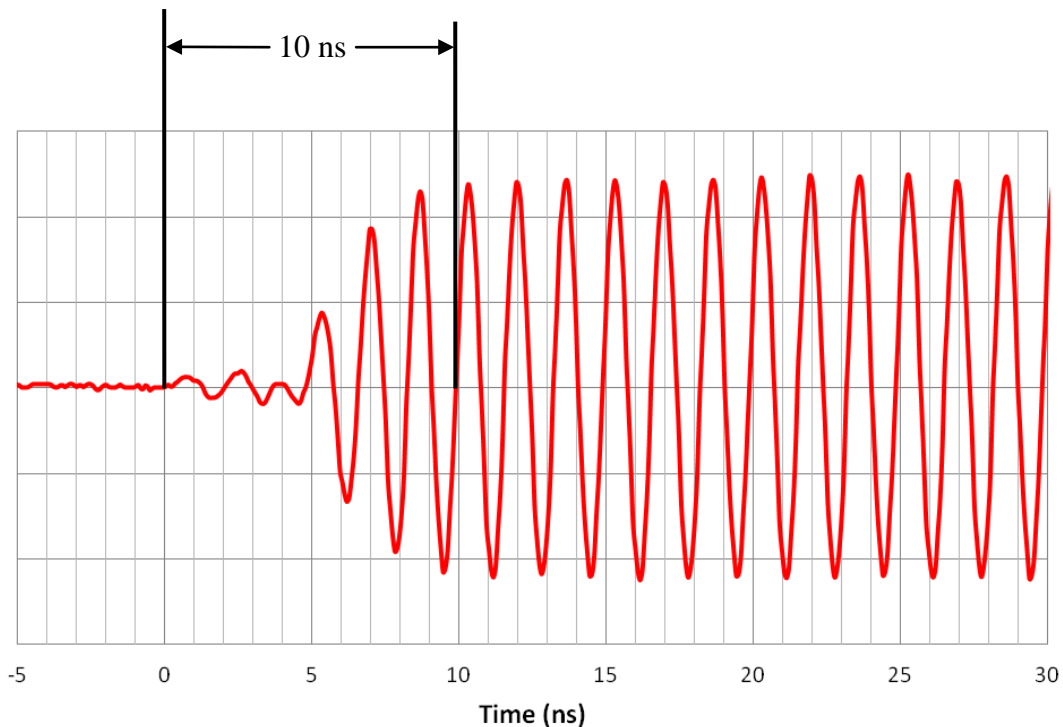

Figure 1: External Pulse Modulation Rise Time (seconds)

ENVIRONMENTAL SPECIFICATIONS¹

Environmental specifications are based on component margins, thermal verification testing and current draw tests. Production unit performance is not verified over temperature.

PARAMETER	MIN	TYPICAL	MAX	COMMENTS
Operating Temperature	0 C		+55 C	
Temperature Monitor Range	-40 C		+85 C	Absolute, channel dedicated outputs
AC Power Supply	100 V _{AC}		240 V _{AC}	50 – 60Hz
Power Consumption				
Base Power Consumption		5 W		
Channel ≤ 6.4 GHz		7 W		
12 or 20GHz Channel		15 W		
Warm-Up Time		10 min	20 min	20 C (ambient temp. dependent)

¹ Specifications are subject to change per the discretion of Holzworth Instrumentation, Inc

DESCRIPTION	SPECIFICATION (by design)
Operating Environment Humidity Altitude Vibration	RH 20% to 80% at wet bulb temp. <29C (non-condensing) 0 to 2,000m (0 to 6,561 feet) 0.21 G-rms maximum, 5Hz to 500Hz
Storage (Non-Operating) Temperature Humidity Altitude Vibration	-10C to + 60C RH 20% to 80% at wet bulb temp. <40C (non-condensing) 0 to 4,572m (0 to 15,000 feet) 0.5 G-rms maximum, 5Hz to 500Hz

PHASE DRIFT PERFORMANCE

Holzworth non-PLL based multi-channel RF synthesizers provide superior channel-to-channel phase coherency. The unique architecture also leverages a channel-to-channel phase drift advantage over other synthesis solutions. Figures 1a and 1b demonstrate channel-to-channel phase drift over a 1 hour period under ambient laboratory conditions (20C ±2C).

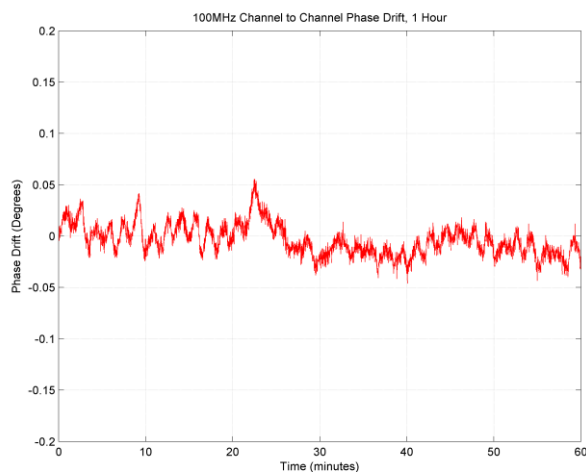

Figure 4a: 100MHz Phase Drift (1hr, 20C)

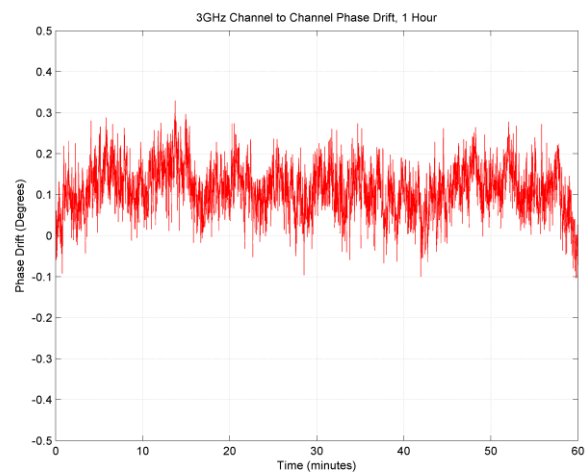

Figure 4b: 3GHz Phase Drift (1hr, 20C)

PHASE NOISE PERFORMANCE

Holworth products are well known for their ultra low phase noise characteristics. All products undergo 100% phase noise performance verification prior to shipment.

SYNTHESIZER CHANNEL PERFORMANCE

The raw data displayed in Figure 2 is of SSB Phase Noise vs. Frequency Offset as measured for the HS9000 Series RF Synthesizers. All data was collected with output power set at +10dBm.

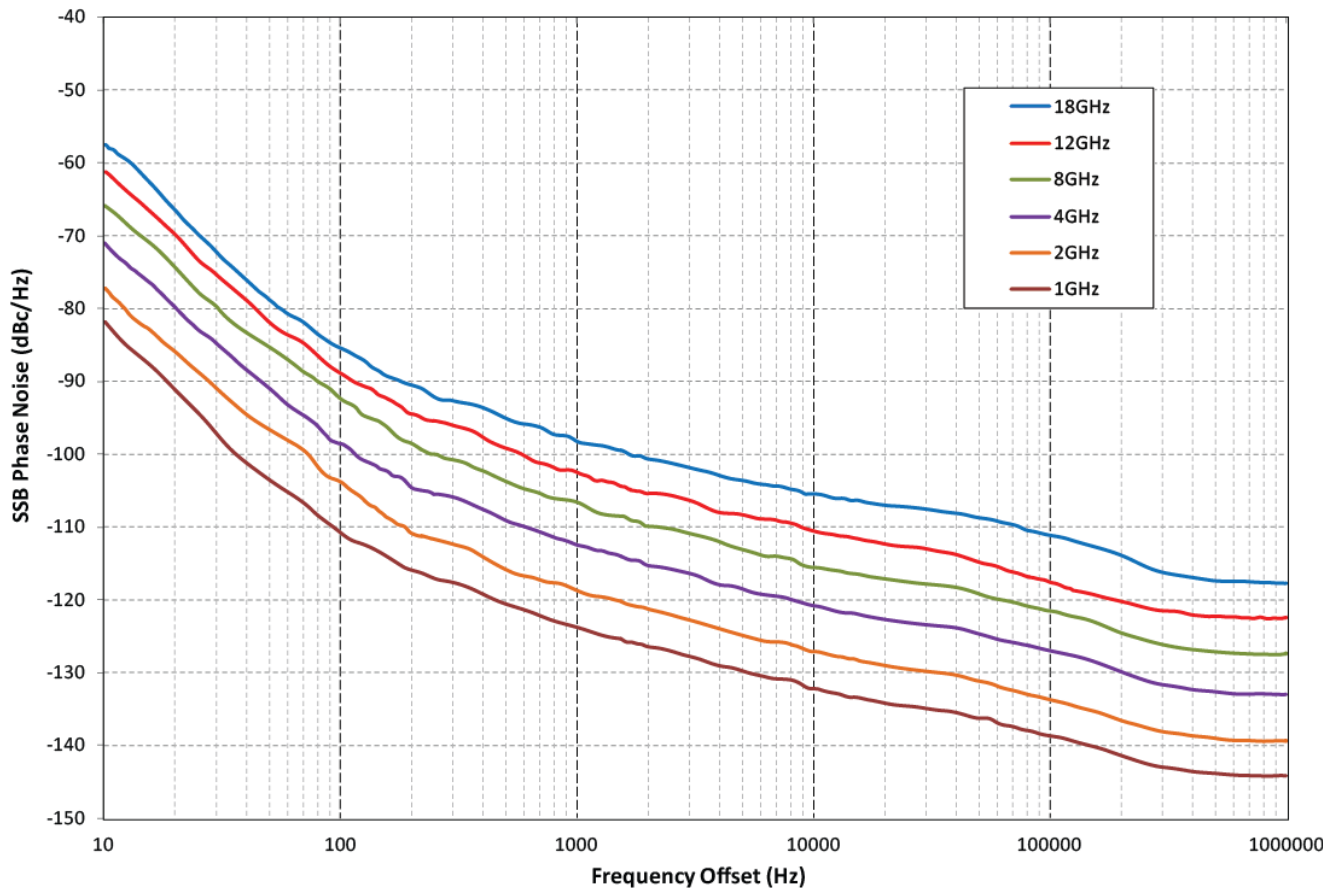

Figure 5: Channel SSB Phase Noise (P_{OUT} = +10dBm)

FIXED REFERENCE OUTPUT PERFORMANCE

The HS9000 Series come equipped with fixed 10MHz and 100MHz reference outputs. The fixed reference output signals are derived directly from the internal reference standard (100MHz OCXO). The data shown in figures 3a and 3b represents typical performance.

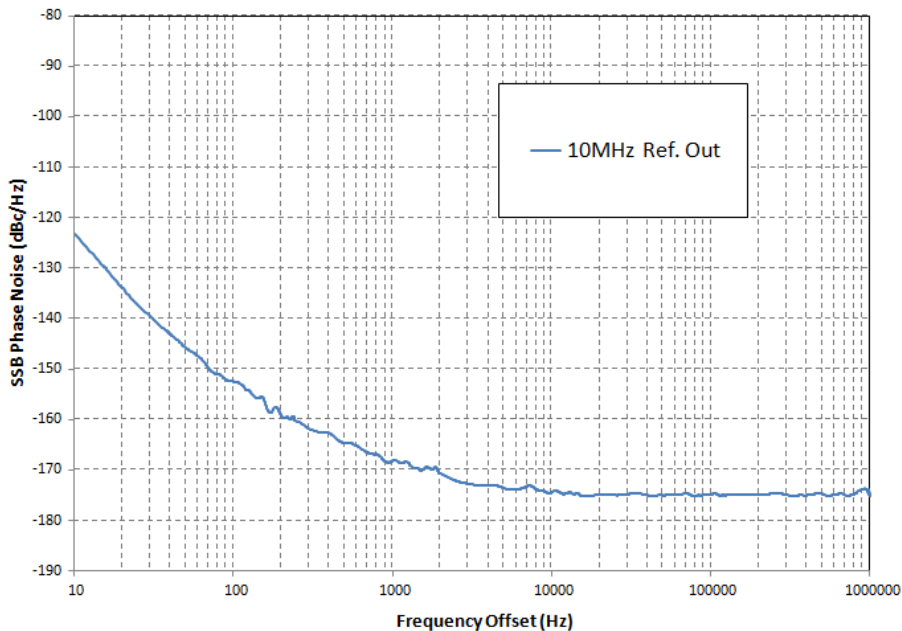

Figure 6a: 10MHz Reference Output SSB Phase Noise

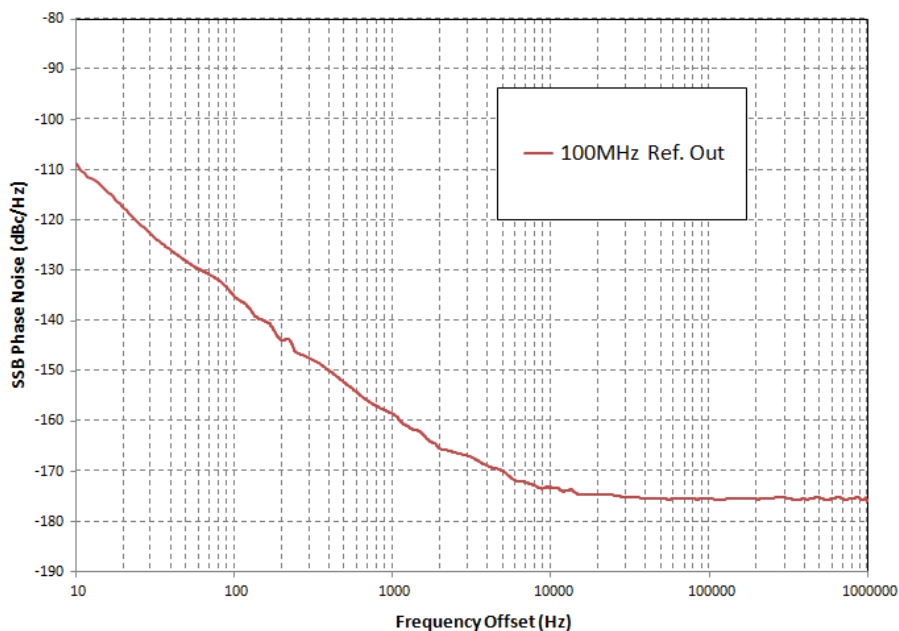

Figure 6b: 100MHz Reference Output SSB Phase Noise

SPECTRAL PURITY DATA

The data contained in this section demonstrates the spectral purity performance of the HS9000 Series designs. Spectrum analyzer test settings: 300kHz Resolution BW, 30kHz Video BW.

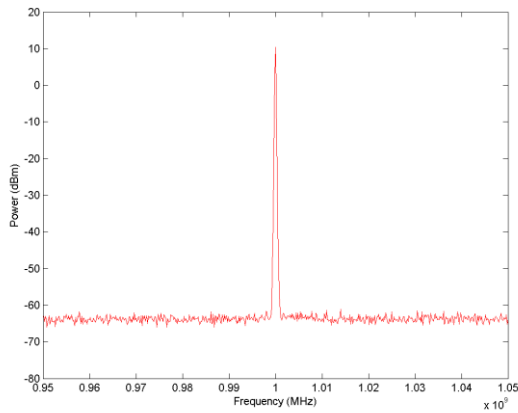

Figure 7a: 1GHz Narrow Band Spectrum

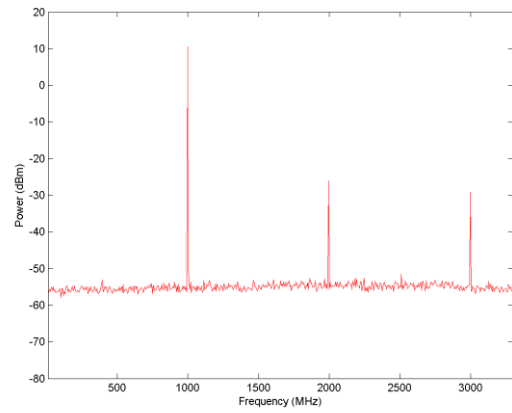

Figure 7b: 1GHz Broad Band Spectrum

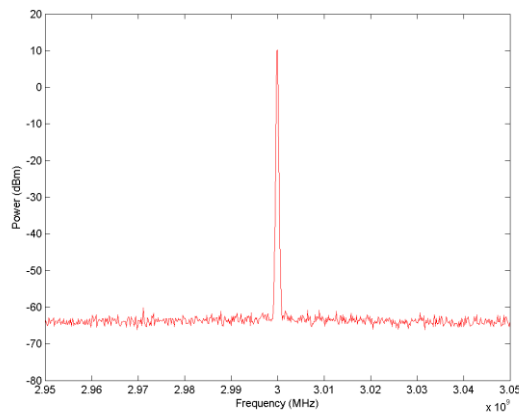

Figure 8a: 3GHz Narrow Band Spectrum

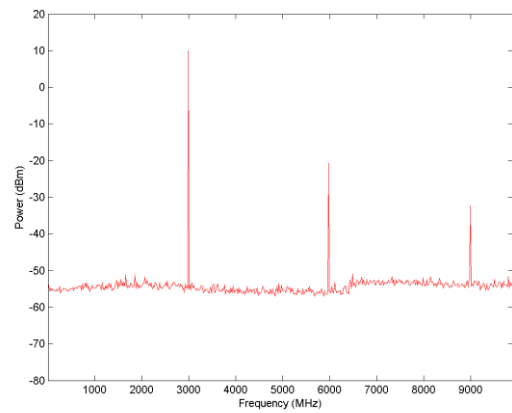

Figure 8b: 3GHz Broad Band Spectrum

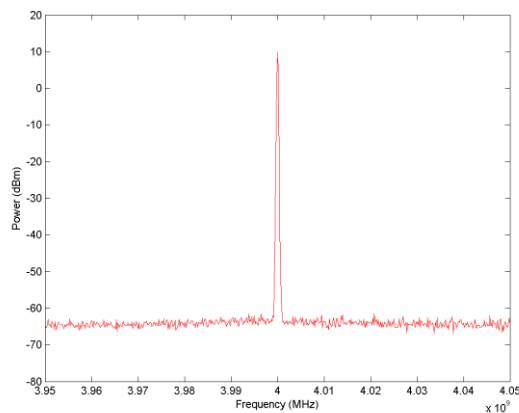

Figure 9a: 4GHz Narrow Band Spectrum

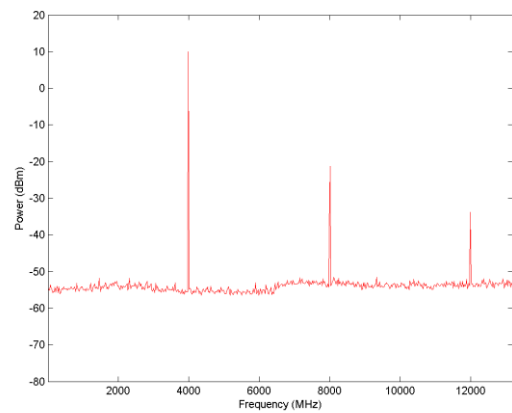

Figure 9b: 4GHz Broad Band Spectrum

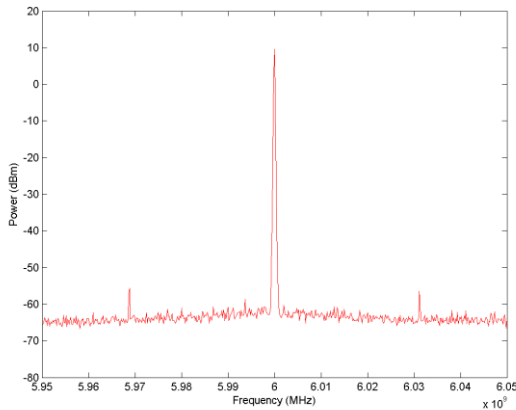

Figure 10a: 6GHz Narrow Band Spectrum

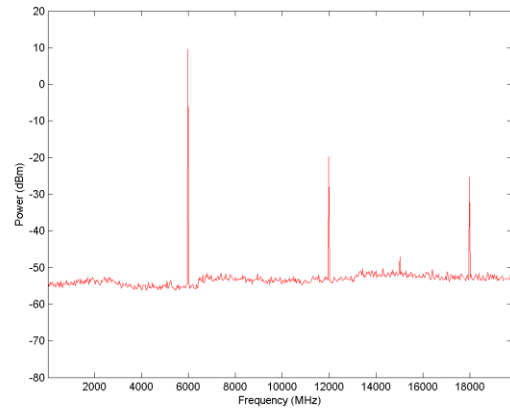

Figure 10b: 6GHz Broad Band Spectrum

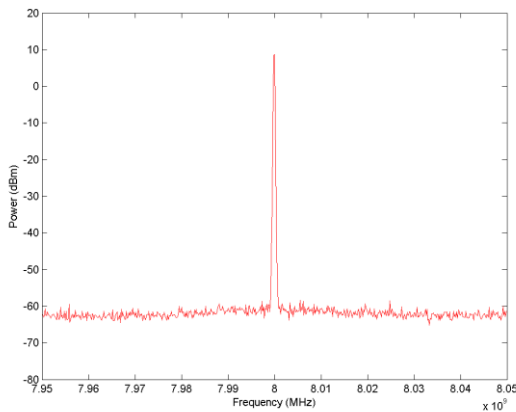

Figure 11a: 8GHz Narrow Band Spectrum

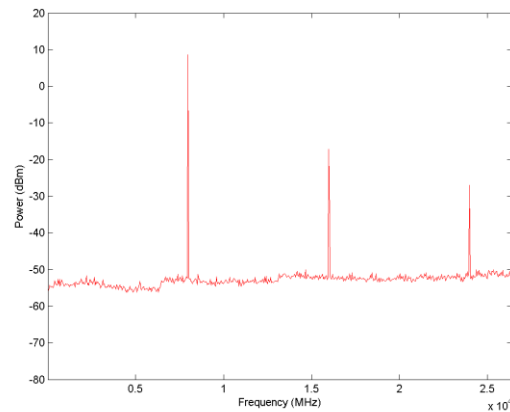

Figure 11b: 8GHz Broad Band Spectrum

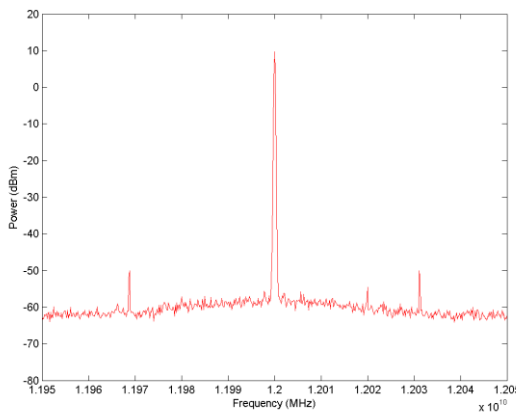

Figure 12a: 12GHz Narrow Band Spectrum

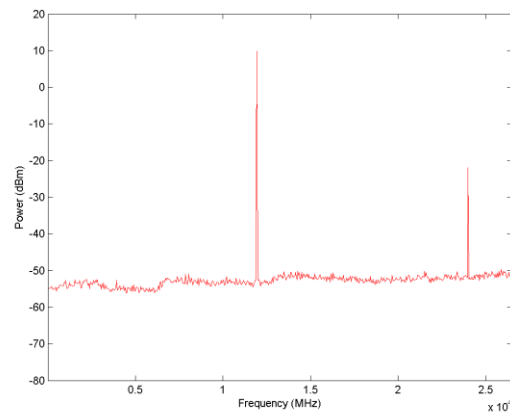

Figure 12b: 12GHz Broad Band Spectrum

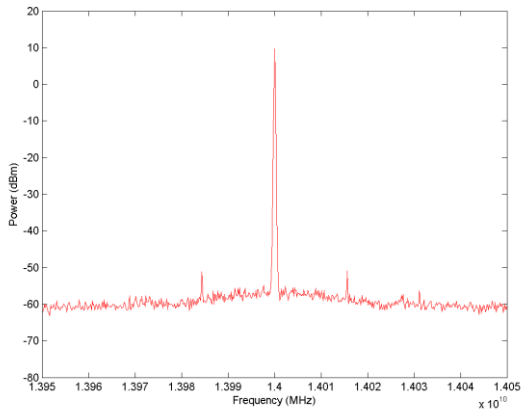

Figure 13a: 14GHz Narrow Band Spectrum

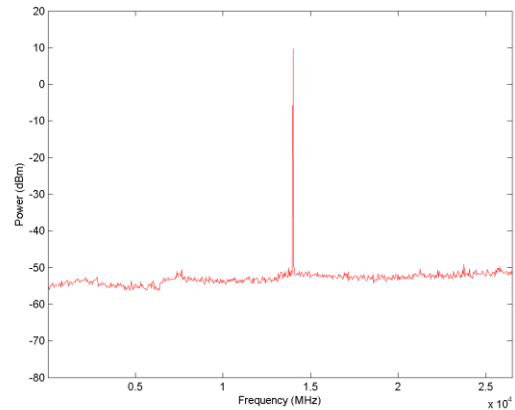

Figure 13b: 14GHz Broad Band Spectrum

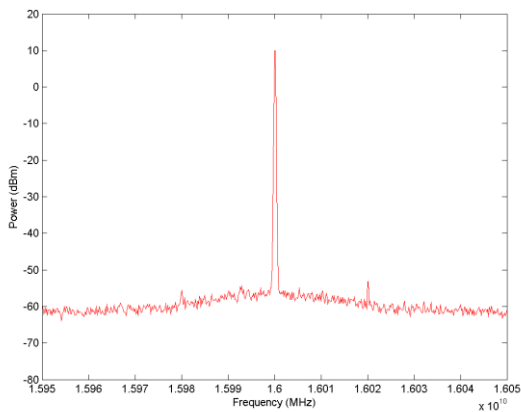

Figure 14a: 16GHz Narrow Band Spectrum

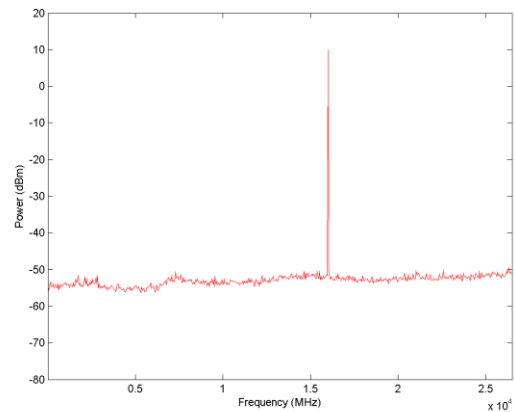

Figure 14b: 16GHz Broad Band Spectrum

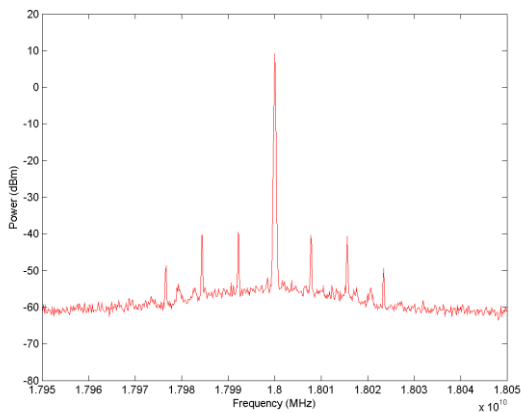

Figure 15a: 18GHz Narrow Band Spectrum

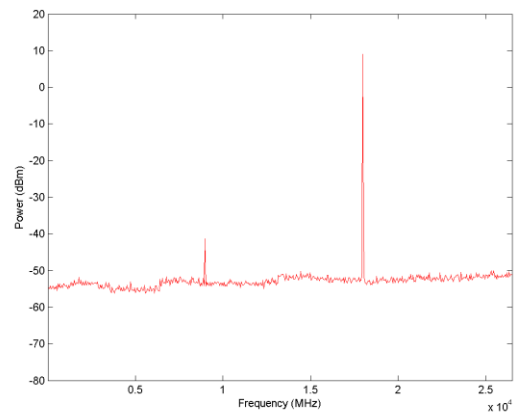

Figure 15b: 18GHz Broad Band Spectrum

Data at additional frequencies available upon request.

HS9000 SERIES CONFIGURATION GUIDE

The HS9000 Series synthesizer platform is designed to be user/application defined. Follow 4 easy steps to determine the part number with the required options.

STEP 1: SELECT TOTAL NUMBER OF CHANNELS

Select the base part number, strictly calling out the total number of channels to be loaded into the multi-channel chassis.

No. Channels	1	2	3	4	5	6	7	8
Part Number	HS9001A	HS9002A	HS9003A	HS9004A	HS9005A	HS9006A	HS9007A	HS9008A

STEP 2: SELECT CHANNEL FREQUENCY OPTIONS

Select any combination of channel frequency options. Note that the total number of channels specified here must equal the number of channels selected under STEP 1.

Frequency Range	Number of Channels per Frequency Range							
	1x	2x	3x	4x	5x	6x	7x	8x
CMOS 5MHz - 200MHz	OPT-CMOS1	OPT-CMOS2	OPT-CMOS3	OPT-CMOS4	OPT-CMOS5	OPT-CMOS6	OPT-CMOS7	OPT-CMOS8
250kHz - 1GHz	OPT-A1	OPT-A2	OPT-A3	OPT-A4	OPT-A5	OPT-A6	OPT-A7	OPT-A8
250kHz - 2GHz	OPT-B1	OPT-B2	OPT-B3	OPT-B4	OPT-B5	OPT-B6	OPT-B7	OPT-B8
250kHz - 3GHz	OPT-C1	OPT-C2	OPT-C3	OPT-C4	OPT-C5	OPT-C6	OPT-C7	OPT-C8
250kHz - 4GHz	OPT-D1	OPT-D2	OPT-D3	OPT-D4	OPT-D5	OPT-D6	OPT-D7	OPT-D8
250kHz - 6.4GHz	OPT-E1	OPT-E2	OPT-E3	OPT-E4	OPT-E5	OPT-E6	OPT-E7	OPT-E8
10MHz - 12.5GHz	OPT-X1	OPT-X2	OPT-X3	OPT-X4	NA	NA	NA	NA
10MHz - 20GHz	OPT-F1	OPT-F2	OPT-F3	OPT-F4	NA	NA	NA	NA

STEP 3: SELECT ADDITIONAL OPTIONS & ACCESSORIES

The options listed in this section are available for the multi-channel platform to comply with application specific requirements.

TYPE	Part Number	Description
OPTION	OPT-EXTMOD-n	Channel dedicated, external modulation input. n= 1, 2, 3, etc. (specify up to 6 ch)
OPTION	OPT-OCXO	High Performance OCXO. 10dB Improved Phase Noise at close to the carrier
OPTION	OPT-PWR18-n	+20dBm maximum output power level. n= 1, 2, 3, etc. (specify for up to 5 channels) ¹
ACCESSORY	HCM5	Ethernet Control Module
ACCESSORY	RACK-1U	19" Rack Mount Bracket Kit, 90° rear bracket
ACCESSORY	RACK2-1U	19" Rack Mount Bracket Kit, straight rear bracket

¹ Available for channels up to 6.4GHz maximum output only.

PART NUMBER EXAMPLE

Ordering a 5 channel synthesizer with 1x CMOS channel, 1x 3GHz channels, 2x 6.4GHz channels, 2x 12GHz and a high performance OCXO would result in the following configuration:

Part Number:	HS9005A	Description:	5 ch, Multi-Channel RF Synthesizer
Options:	OPT-CMOS1		1x CMOS Channel
	OPT-C1		1x 3GHz Channel
	OPT-E2		2x 6.4GHz Channels
	OPT-X1		1x 12.5GHz Channel
	OPT-OCXO		High Performance OCXO

OPTION SPECIFICATIONS ¹

OPT-CMOS

Option OPT-CMOS is an additional channel (or channels) loaded into the multi-channel system. OPT-CMOS provides a CMOS logic output signal, which may be optimal for a system that requires square wave trigger or clock signals.

PARAMETER	MIN ²	TYPICAL ³	MAX ²	COMMENTS
Frequency Range	5MHz		500MHz	
Output Voltage (CMOS Logic)		0V - 5V		0V to 2.5V into 50Ω
Phase Noise				
10MHz, 10kHz Offset		-152 dBc/Hz	-145 dBc/Hz	
19.2MHz, 10kHz Offset		-154 dBc/Hz	-145 dBc/Hz	
100MHz, 10kHz Offset		-152 dBc/Hz	-143 dBc/Hz	
200MHz, 10kHz Offset		-146 dBc/Hz	-135 dBc/Hz	
Rise Time / Fall Time (Tr / Tf)		900ps		
Output Impedance		50Ω		

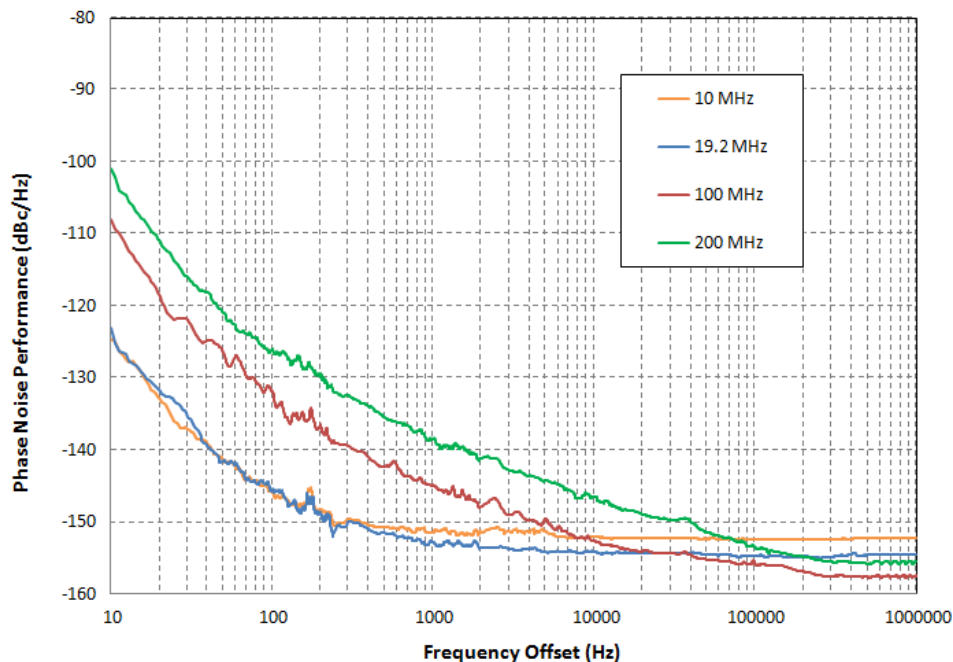

¹ Specifications are subject to change per the discretion of Holzworth Instrumentation, Inc.

² All MIN/ MAX (Minimum/ Maximum) performance parameters are guaranteed and 100% verified during final performance test.

³ Typical performance is "by design" and consistent with field performance data.

OPTION SPECIFICATIONS ¹ CONTINUED

OPT-OCXO

Option OPT-OCXO replaces the standard internal reference (100MHz OCXO) with a higher performing reference source. A phase noise performance improvement of approximately 10dB is realized at close to the carrier. The 1GHz channel output example (below) demonstrates the typical performance with OPT-OCXO versus that of the standard reference oscillator.

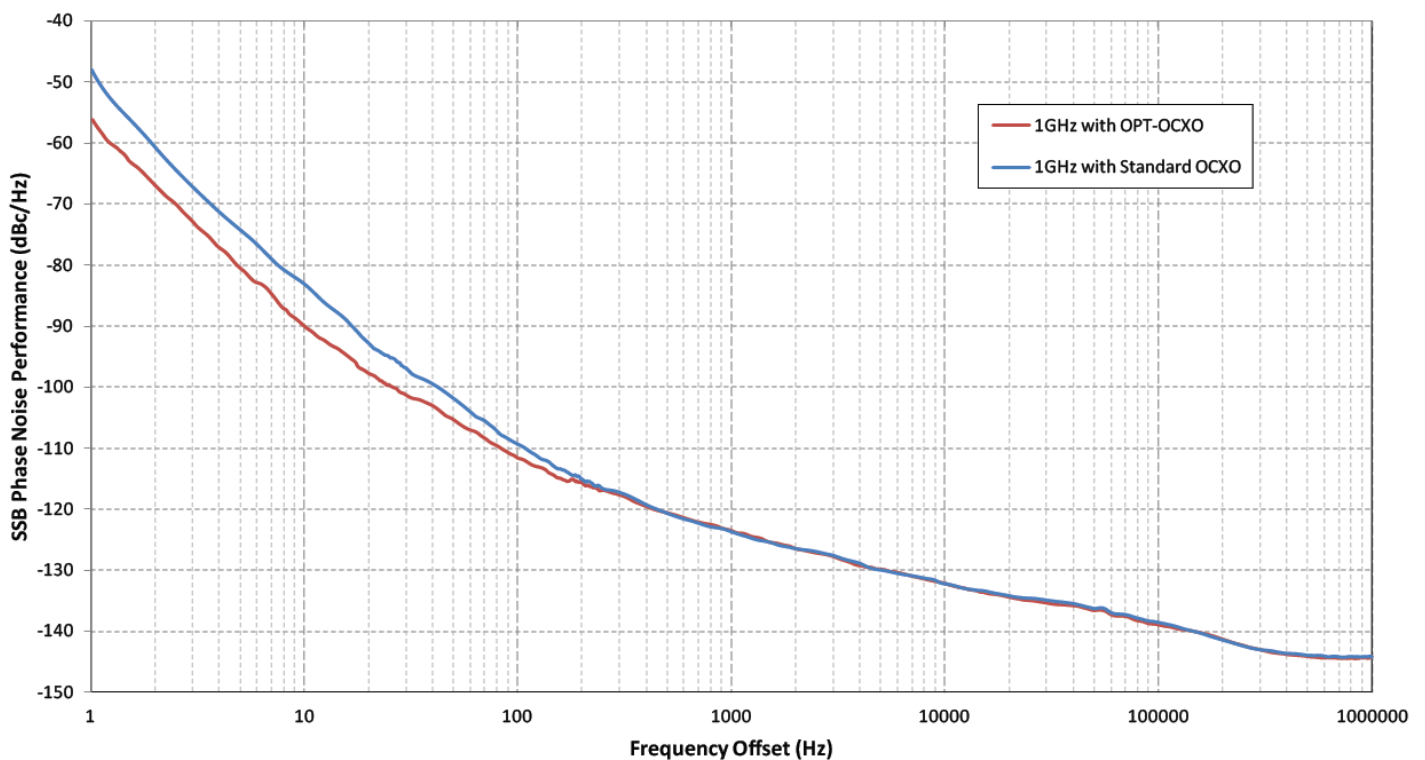

Figure 14: SSB Phase Noise OPT-OCXO Comparison ($P_{OUT}=+10dBm$)

¹ Specifications are subject to change per the discretion of Holzworth Instrumentation, Inc.

² All MIN/ MAX (Minimum/ Maximum) performance parameters are guaranteed and 100% verified during final performance test.

³ Typical performance is "by design" and consistent with field performance data.

OPTION SPECIFICATIONS ¹ CONTINUED

NOTE: OPT-PWR18-n is only available for channel up to 6.4GHz maximum output frequency. Channels with maximum frequency of 12.5 or 20GHz channels come standard with output power calibrated to +18dBm (up to 12GHz) and +16dBm (12GHz to 18GHz).

OPT-PWR18

Option OPT-PWR18 increases the maximum output power to a typical value of +20dBm. amplifiers are designed to contribute the lowest additive phase noise possible, as well as to maintain signal stability across all frequencies.

PARAMETER	MIN ²	TYPICAL ³	MAX ²	COMMENTS
Frequency Range	10MHz		6.4GHz	Based on channel max. freq.
Absolute Level Accuracy				
10MHz < f < 32MHz	+18 to -60dBm	+0.20/ -1.5 dB	+1/ -3 dB	40C (case temperature)
32MHz < f < 4.096GHz	+18 to -20dBm	± 0.20 dB	± 0.60 dB	
32MHz < f < 4.096GHz	-20 to -60dBm	± 0.3 dB	± 1.0 dB	
4.096GHz < f < 6.4GHz	+18 to -20dBm	± 0.2 dB	± 0.6 dB	
4.096GHz < f < 6.4GHz	-20 to -50dBm	± 0.3 dB	+1.0/ -1.5 dB	
Harmonics (CW mode, Pout = 0dBm)				
10 MHz to 64 MHz		-20 dBc	NS	
Pout = +10dBm		-40 dBc	-30dBc	
Non-Harmonics (CW mode)				
10 MHz to 64 MHz		-50 dBc	NS	@ 0 dBm
64 MHz to 3.072 GHz		-70 dBc	-60 dBc	
3.072 GHz to 6.400 GHz		-60 dBc	-50 dBc	
Sub-Harmonics (CW mode)				
10 MHz to 64 MHz		-50 dBc	NS	@ 0 dBm
64 MHz to 3.072 GHz		-70 dBc	-60 dBc	
3.072 GHz to 6.400 GHz		-60 dBc	-50dBc	
Case Operating Temperature		40 C		Calibrated at typical case temperature ⁴ .
Power Consumption		5 W		Additional 5 W per Channel.
Warm-Up Time		10 min	20 min	20 C (ambient temp. dependent)
Output Impedance		50Ω		

¹ Specifications are subject to change per the discretion of Holzworth Instrumentation, Inc.

² All MIN/ MAX (Minimum/ Maximum) performance parameters are guaranteed and 100% verified during final performance test.

³ Typical performance is "by design" and consistent with field performance data.

⁴ OPT-PWR18 calibration is sensitive to changes in temperature while at the same time introducing excess heat due to power dissipation. Holzworth recommends using airflow to maintain constant 40C (±5C) case operating temperature.

OPTION SPECIFICATIONS ¹ CONTINUED**OPT-HCM5**

An Ethernet connection is available via the back panel of the instrument using part number: HCM5 (USB Communication Module for HA7000 Series). The HCM5 module comes with a standard 10ft (3m) CAT-6 Ethernet cable.



The HCM5 is installed directly to the DB25 connector located at the left side of the rear panel, using the 2x captive panel screws to securely fasten the HCM5 into position. Once the HCM5 is installed, an Ethernet cable can be used to connect the instrument directly to a PC or to a network.

NOTE 1: USB INACTIVATED. Once the HCM5 module is physically mated to the synthesizer, USB control will no longer be available to the user. This scenario is valid whether or not an Ethernet cable is installed. To regain a USB connection, the HCM5 module must be completely removed from the instrument.

NOTE 2: For direct PC connection via Ethernet (non-networked) a cross over Ethernet cable is required.

¹ Specifications are subject to change per the discretion of Holzworth Instrumentation, Inc.

MECHANICAL CONFIGURATION

The HS9000 Series comes in a 1U high, rack mountable chassis. The example shown is of a 6 channel unit (front panel configuration may vary). A universal rack mount bracket kit is an available accessory (Part No.: RACK-1U or RACK2-1U). Mechanical dimensions are listed in inches (and millimeters).

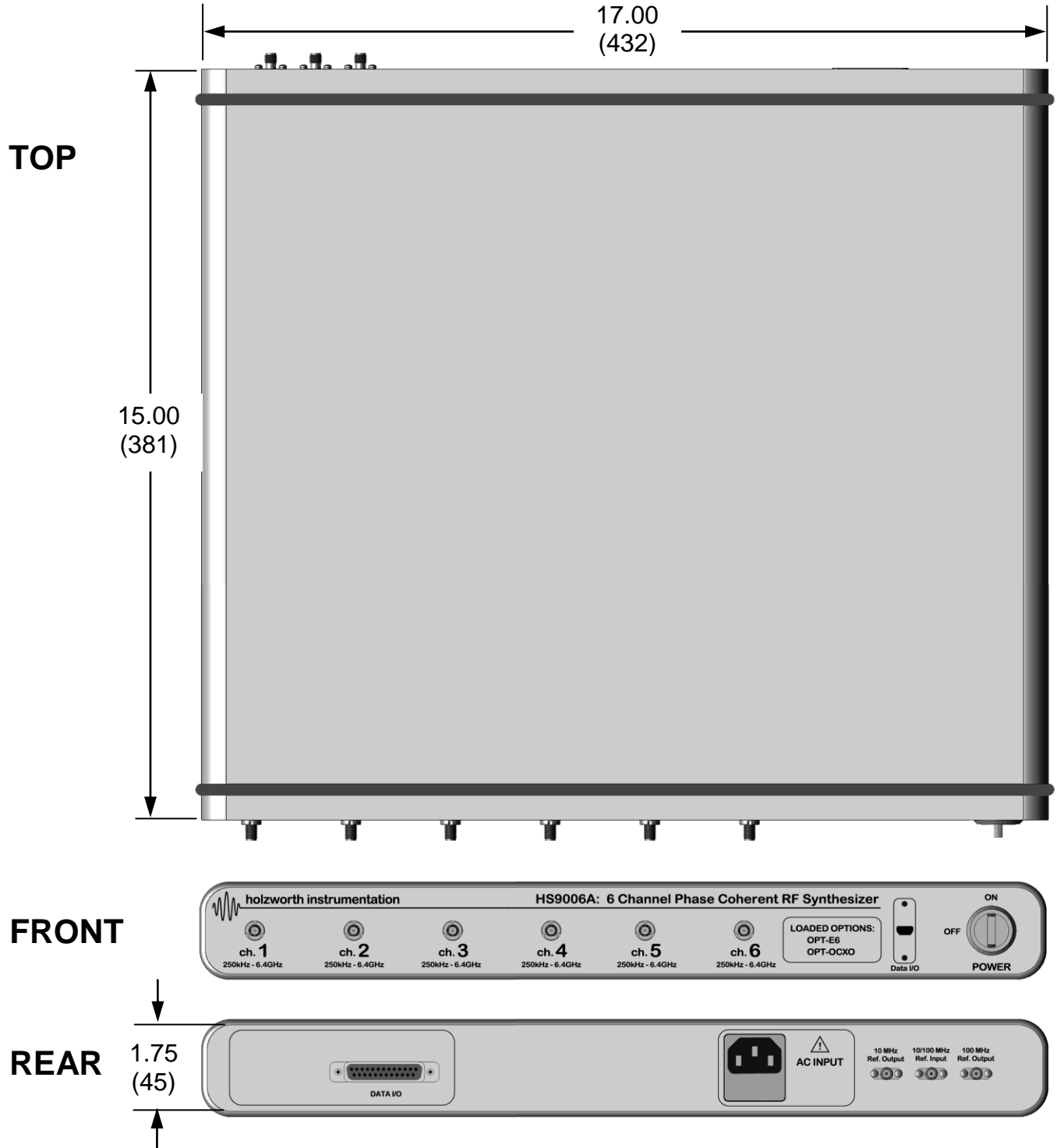

INCLUDED HARDWARE AND CERTIFICATIONS

Each product delivery includes specific, standard hardware and certifications.

TYPE	DESCRIPTION	COMMENTS
HARDWARE	HS9000 SERIES SYNTHESIZER	DELIVERABLE
HARDWARE	EXTERNAL AC POWER CORD ¹	DELIVERABLE
HARDWARE	10ft CAPTIVE PANEL USB CABLE	DELIVERABLE
WARRANTY	2 YEAR MANUFACTURER'S WARRANTY	NON-APPLICABLE
CERTIFICATE	CALIBRATION CERTIFICATION	DELIVERABLE
CERTIFICATE	CE COMPLIANCE CERTIFICATE <i>DIRECTIVE: 2004/108/EC, TEST STANDARD: EN 61326-1: 2006</i>	WEB DOWNLOAD
CERTIFICATE	RoHS COMPLIANCE CERTIFICATE <i>DIRECTIVE: 2002/95/EC</i>	WEB DOWNLOAD
CERTIFICATE	WEEE COMPLIANCE STATEMENT <i>DIRECTIVE: 2002/96/EC</i>	WEB DOWNLOAD

¹Specify country code for power cord

CONNECTORS and PHYSICAL SPECIFICATIONS

Front Panel	Description	Channel Output (1 – 8)	Modulation Input ¹	USB Data I/O (1)
	Type	SMA JACK	SMA JACK	Mini-B JACK
Rear Panel	Description	AC Input	Ref.In (1), Ref. Out (2)	SPI Data I/O (1)
	Type	IEC 60320-1	SMA JACK	DB25 JACK
Physical Dimensions (L x W x H)		1U high, 19" rack mount: 15in x 17in x 1.75in (381mm x 431.8mm x 44.5mm)		
Weight		30 lb (13.6 kilograms) MAXIMUM		

¹Channels equipped with OPT-EXTMOD only.

INCLUDES: 1x captive lock USB 2.0 cable (10ft/3m), and 1x AC power cord (6ft/1.8m). Specify country code for power cord.

EXTERNAL DB25 CONNECTOR DIAGRAM

The HS9000 Series is equipped with a rear-mounted DB25 connector that can be used to communicate with the instrument over SPI (See Appendix D for more information).

Onboard Connector Part Number:

TE Connectivity 5745783-2

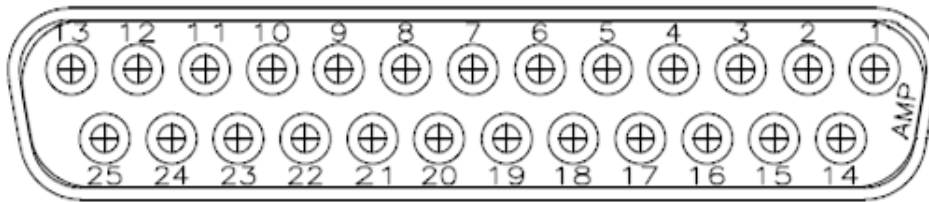

PIN	Label	PIN	Label
1	GND	14	/CS-CH0-REF
2	SDI	15	/CS-CH1
3	SDO	16	/CS-CH2
4	SCLK	17	/CS-CH3
5	PWRGOOD	18	/CS-CH4
6	READY	19	/CS-CH5
7	/ERROR	20	/CS-CH6
8	NC	21	/CS-CH7
9	/CH-RESET	22	/CS-CH8
10	/SPI_EN	23	NC
11	NC	24	NC
12	NC	25	+5V
13	GND		

EXTERNAL DB25 CONNECTOR PIN DEFINITIONS

+5V	5V DC Output
SDI	Serial Data Input (synthesizer module/slave data out). High-Z input on module. 3.3V logic levels, 5V tolerant. 47k pulldown.
SDO	Serial Data Output (synthesizer module/slave data out). High-Z input on module. 3.3V logic levels, 5V tolerant. 47k pulldown.
SCLK	SPI Clock (slave clock input). Idle low, active high. Data is transitioned into the module on a rising low to high transition. Data is transitioned out on the same edge and is valid on the falling edge of SCLK. 3.3V logic levels, 5V tolerant. 47k pulldown.
PWRGOOD	Open collector output, 47k pullup to 3.3V. When high, power is healthy. When low, either voltages or currents are problematic. Modules may not operate correctly. There is a 0.5 second delay from when power is applied to a valid PWRGOOD. Actual PWRGOOD may take up to 2 seconds to go high due to some very stable internal references that require settling.
READY	Open collector output, 47k pullup to 3.3V. Nominally high. After an SPI communication, if a command has been issued then READY will go active low. During this time no communication may occur and SPI bus will be asleep.
/ERROR	Open collector output, 47k pullup to 3.3V. nominally high. If an error condition occurs, such as a PLL unlock or un-leveled condition, this will go active low.
/CH-RESET	Active low on this pin puts the module in reset, releasing it returns to reset operation. Module is ready 2-3 seconds after /RESET is released. 47k pullup to 3.3V in parallel to 0.01uF cap to ground.
/SPI_EN	Disables the USB communication that has control of the bus. Only when driven low should the user apply any signal to the lines.
/CS	Communications chip select, active low. 47k pullup on this line. /CS must be low for any communication to occur. Allows for multiple synthesizer modules on a single SPI bus. 3.3V logic levels, 5V tolerant.
NC	These are reserved lines. Should be left floating.

SPI COMMUNICATIONS

BUS OVERVIEW

The SPI bus is a byte oriented bus, sending 8bits at a time. Any number of bytes may be sent, from 1 byte to 64 bytes while chip select is low. Bytes sent beyond 64 bytes will be ignored. The data is held in a buffer until chip select goes high, initiating the parsing of the data and execution of the commands. The maximum speed of the bus is 10Mbps/s. Data may be written to the module and data may be received from the module. After a command is sent requesting data, the next transfer sends this data out on SDO. During the read, a new command may be send and will be parsed when chip select goes high. A read is always followed by a write with a read request.

BUS HARDWARE PROTOCOL

Data is clocked into the module on the rising edge of sclk. Data is clocked out of the module on this same edge. Data output is valid on the falling edge of sclk. Data is only transferred when chip select is low. When chip select goes high, this initiates the parsing and execution of data.

SPI TIMING

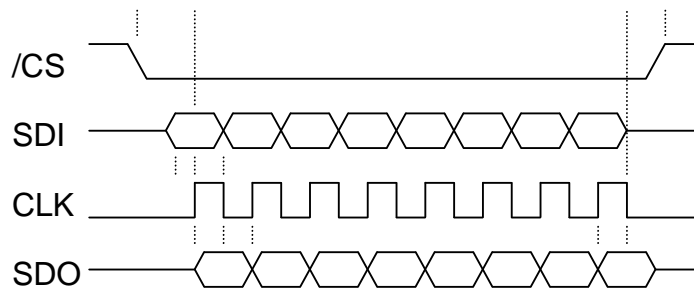

The figure above demonstrates bit level timing where data is sampled into and out of the module on the rising edge of SCLK (Slave Clock). Data out is valid on the falling edge of SCLK.

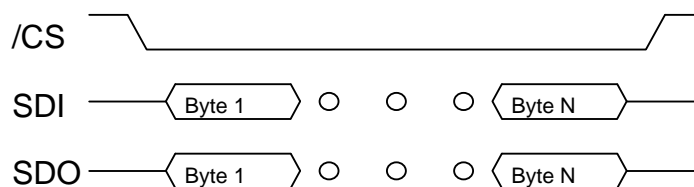

The above figure displays how byte level communications occurs. Any number of bytes may be sent. After /CS goes high, the data is parsed and executed. If no data is sent, the SPI communications module simply resets itself and no parsing or execution of data occurs. If /CS goes high in the middle of a byte transfer (1-7 bits are sent instead of 8) this byte is ignored.

INTERFACE - GUI

The HS9000 Series hardware utilizes a virtual front panel as the visual interface. Each unit comes with an open license to operate the application on any standard PC, including those equipped with touch screen monitors. The analyzer operates under the HID (Human Interface Device) protocol, which means there are no drivers to install. The Java™ based application GUI compliments the driver free instrument by being extremely reliable. The open DLL can also be directly accessed for control of the unit via MATLAB™, LabVIEW™, C++ code, VB code, etc.

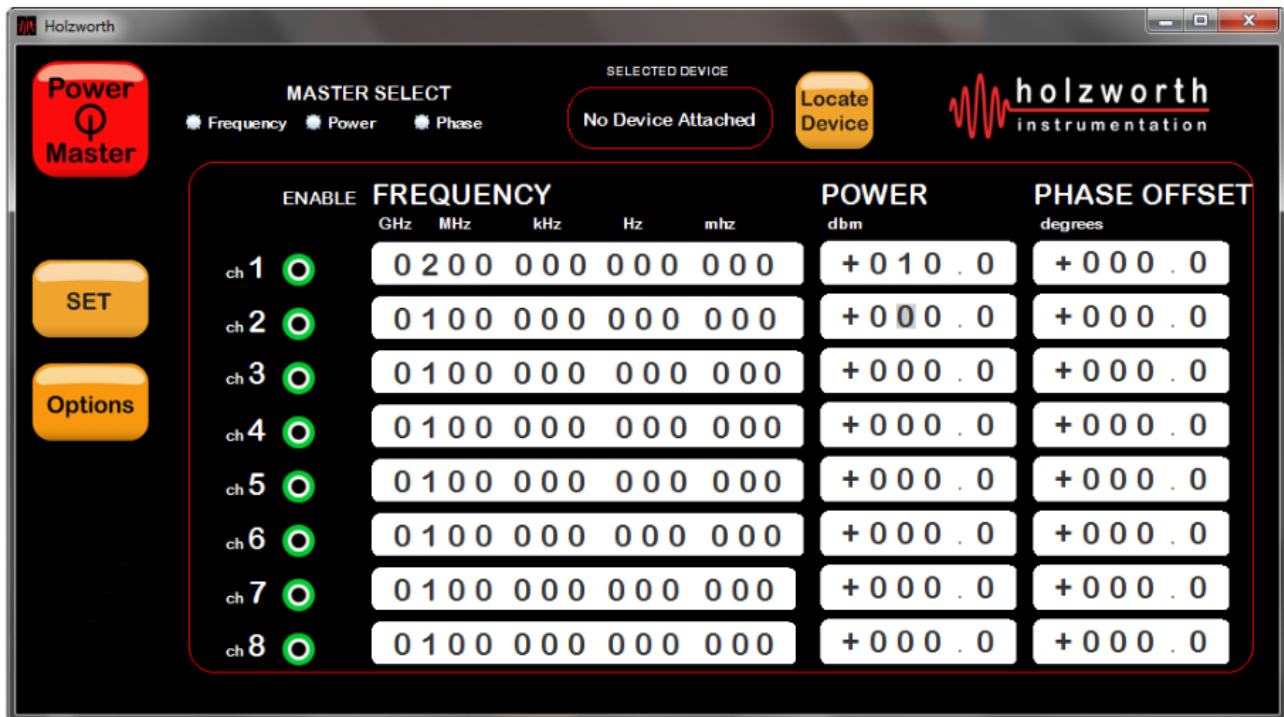

WARRANTY

All Holzworth synthesizer products come with a standard 3 year 100% product warranty covering manufacturing defects. All product repairs and maintenance must be performed by Holzworth Instrumentation. Holzworth reserves the right to invalidate the warranty for any products that have been tampered with or used improperly. Refer to Holzworth Terms & Conditions of Sales for more details.

Holzworth products are proudly designed and manufactured in the USA.

**CONTACT INFORMATION**

Contact Holzworth directly for a product quotation, a product demonstration, or for technical inquiries.

Holzworth Instrumentation Sales Support

Phone: +1.303.325.3473 (option 1)

Email: sales@holzworth.com

Holzworth Instrumentation Technical Support

Phone: +1.303.325.3473 (option 2)

Email: support@holzworth.com

www.HOLZWORTH.com